

# Poignées D-SIGN Montage Simple

Façade de  
finition

Manoeuvrante Intérieure

Fixe Intérieure

D-SIGN  
+ Façade de  
finition

DS7719

DS7971-D/G  
DS7972-D/G

DS7975

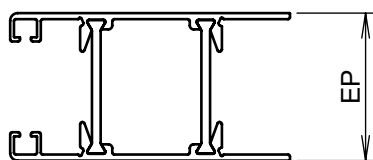
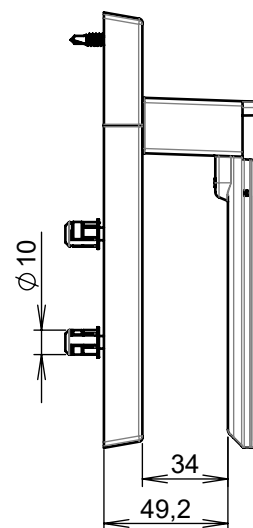
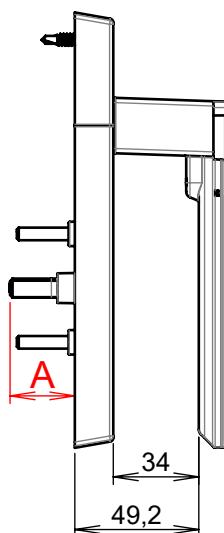
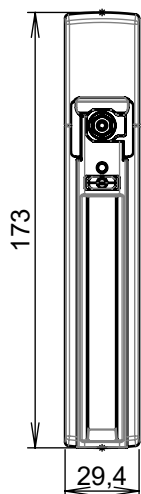
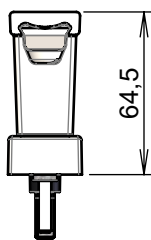
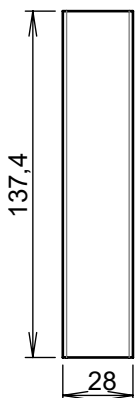
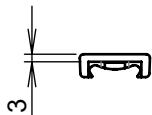
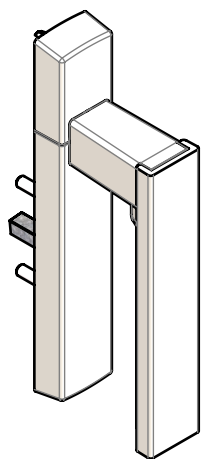

Epaisseur Profil	réf poignée manoeuvrante	valeur <b>A</b>	réf poignée fixe
28 à 35mm	DS7971-D/G	25.7	DS7975
35 à 50mm	DS7972-D/G	32.7	DS7975
50mm et plus	voir tableau en dessous		DS7975

Axe crémonne

Profils renforcé tubulaire

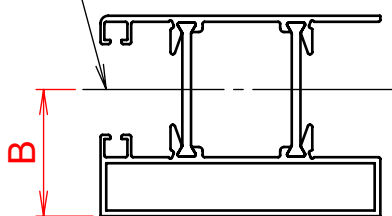

<b>B</b>	réf poignée manoeuvrante	valeur <b>A</b>	longueur carré après recoupe	rallonge DS6100A	kit de fixation	valeur <b>C</b>
25 à 30mm	DS7972-D/G	32.7	pas de recoupe	x	DS2410	45
30 à 35mm	DS7972-D/G	32.7	B-11±1mm	OUI	DS2411	50
35 à 40mm	DS7972-D/G	32.7	B-11±1mm	OUI	DS2412	55
40 à 45mm	DS7972-D/G	32.7	B-11±1mm	OUI	DS2413	60

Kit de fixation

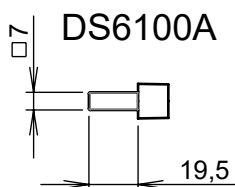
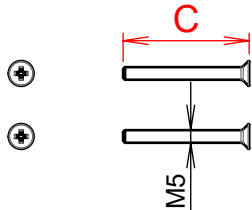

# Poignées D-SIGN Montage Double

## Manoeuvrantes Intérieures

## Manoeuvrantes Extérieures

D-SIGN  
+ Façade de  
 finition

Façade de  
 finition  
DS7719

DS7971-D/G  
DS7972-D/G

DS7944-D/G

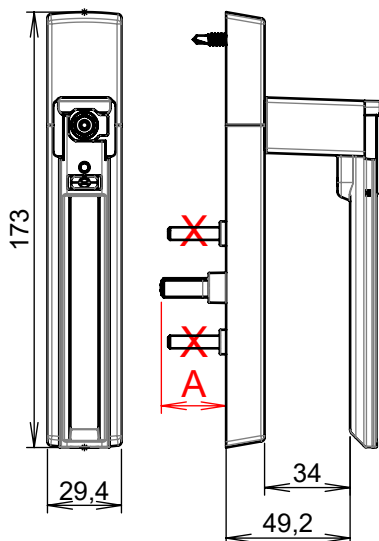
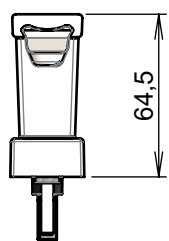
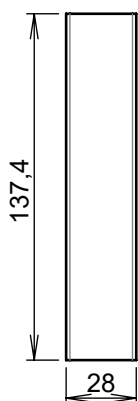
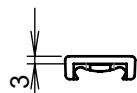
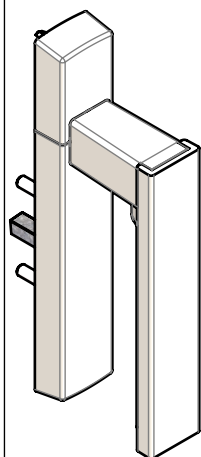

**X** remplacer vis  
par kit de fixation

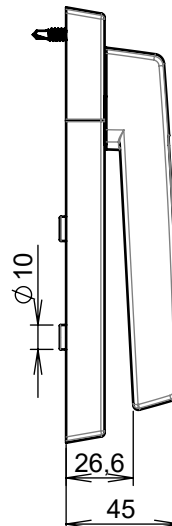
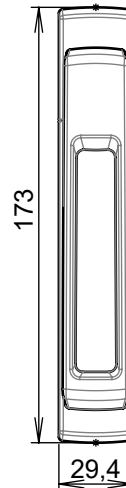
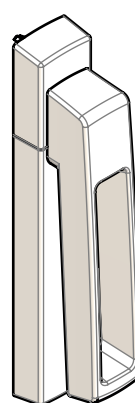

+ kit de fixation

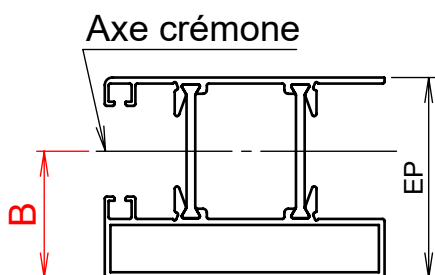
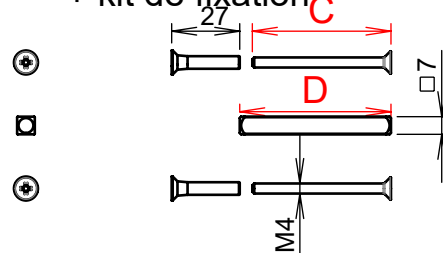

rallonge de carré  
DS6100A

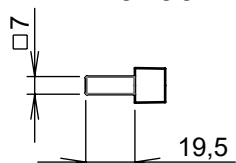

Epaisseur Profils	Réf poignées intérieure	valeur A	Réf kit de fixation	valeur C	valeur D
31.5 à 33.5	DS7971-D/G	25.7	DS2675	40	56
33.5 à 35	DS7971-D/G	25.7	DS2621	50	58
35 à 35.5	DS7972-D/G	32.7	DS2621	50	58
35.5 à 37.5	DS7972-D/G	32.7	DS2564	55	60
37.5 à 39.5	DS7972-D/G	32.7	DS2622	55	62
39.5 à 41.5	DS7972-D/G	32.7	DS2561	50	64
41.5 à 43.5	DS7972-D/G	32.7	DS2623	60	66
43.5 à 45.5	DS7972-D/G	32.7	DS2624	60	68
45.5 à 47.5	DS7972-D/G	32.7	DS2565	55	70
47.5 à 49.5	DS7972-D/G	32.7	DS2625	60	72
49.5 à 51.5	DS7972-D/G	32.7	DS2563	60	74
51.5 à 53.5	DS7972-D/G	32.7	DS2626	60	76
53.5 à 55.5	DS7972-D/G	32.7	DS2627	60	78
55.5 à 57.5	DS7972-D/G	32.7	DS2628	60	80
57.5 à 59.5	DS7972-D/G	32.7	DS2662	70	82
59.5 à 61.5	DS7972-D/G	32.7	DS2658	70	84
61.5 à 63.5	DS7972-D/G	32.7	DS2661	70	86
63.5 à 65.5	DS7972-D/G	32.7	DS2877	70	88
65.5 à 67.5	DS7972-D/G	32.7	DS2682	70	90
67.5 à 69.5	DS7972-D/G	32.7	DS2660	70	92

Si B>30mm:  
recoupe du carré à la longueur :B-11±1mm  
utilisation de la rallonge DS6100A

# Poignées D-SIGN Montage Double

Façade de  
 finition

Manoeuvrante Intérieure

Manoeuvrante Extérieure

D-SIGN  
+ Façade de  
 finition

DS7719

DS7971-D/G  
DS7972-D/G

DS7792-D/G

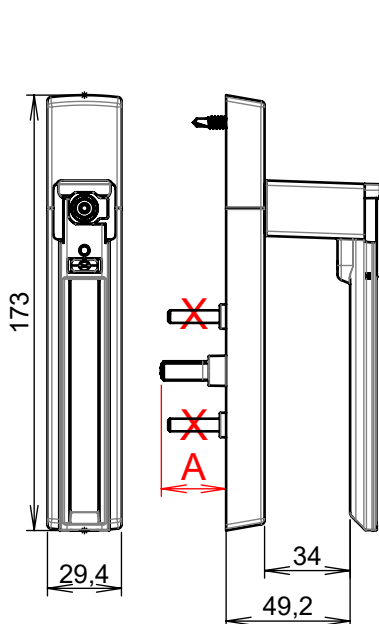
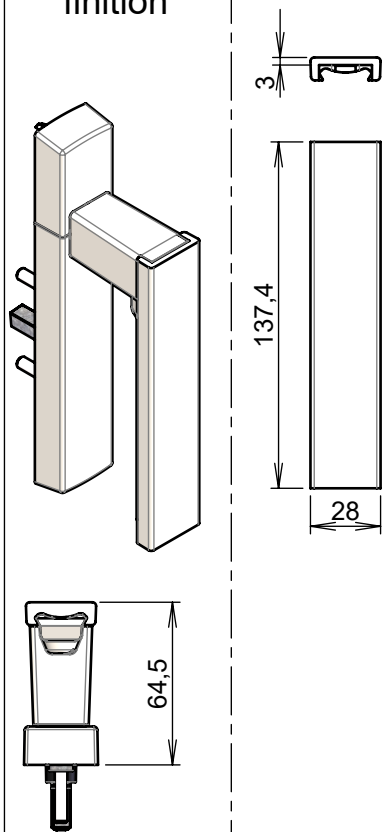

**X** remplacer vis  
 par kit de fixation

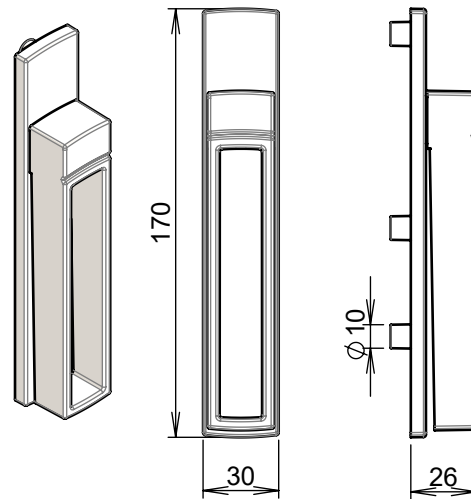

+ kit de fixation

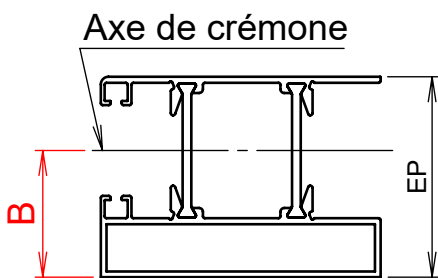
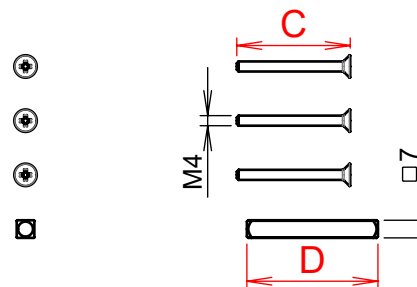

rallonge de carré  
DS6100A

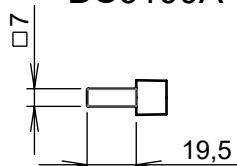

Epaisseur Profils	Réf poignées intérieure	valeur A	Réf kit de fixation	valeur C	valeur D
31 à 33	DS7971-D/G	25.7	DS2851	45	50
33 à 35	DS7971-D/G	25.7	DS2633	45	52
35 à 37	DS7972-D/G	32.7	DS2852	45	54
37 à 39	DS7972-D/G	32.7	DS2635	50	56
39 à 41	DS7972-D/G	32.7	DS2636	50	58
41 à 43	DS7972-D/G	32.7	DS2637	55	60
43 à 45	DS7972-D/G	32.7	DS2638	55	62
45 à 47	DS7972-D/G	32.7	DS2853	55	64
47 à 49	DS7972-D/G	32.7	DS2640	60	66
49 à 51	DS7972-D/G	32.7	DS2641	60	68
51 à 53	DS7972-D/G	32.7	nous contacter		
53 à 55	DS7972-D/G	32.7	nous contacter		
55 à 57	DS7972-D/G	32.7	nous contacter		
57 à 59	DS7972-D/G	32.7	DS2683	70	76
59 à 61	DS7972-D/G	32.7	DS2762	70	78

Si B>30mm:  
recoupe du carré à la longueur :B-11±1mm  
utilisation de la rallonge DS6100A

# Poignées D-SIGN Montage Double

Façade  
 de finition

Fixe Intérieure

Fixe Extérieure

D-SIGN  
 + Façade de  
 finition

DS7719

DS7977

DS7947

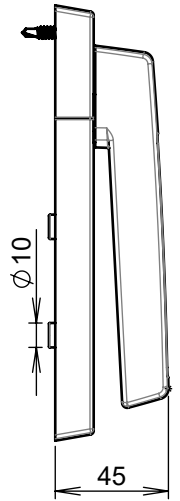
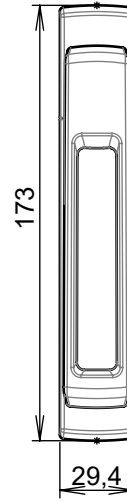
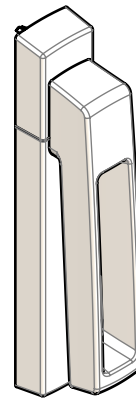
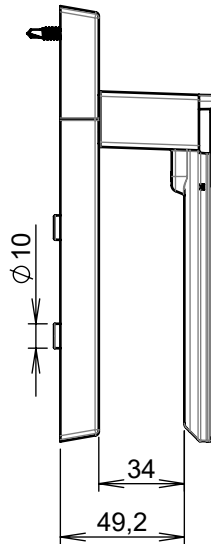
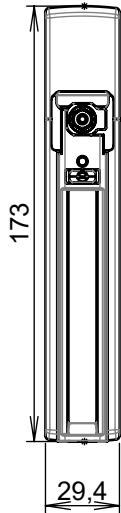
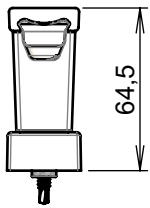
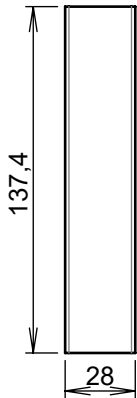
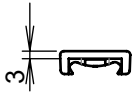
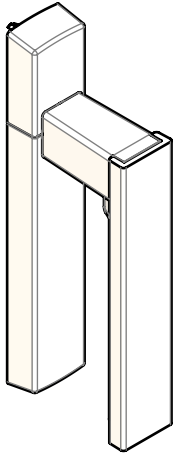

+ kit de fixation

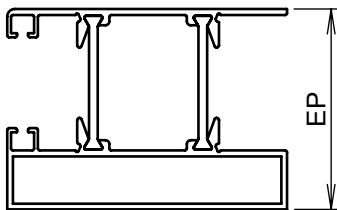
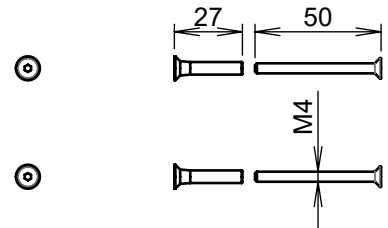

Epaisseur Profils	Réf kit de fixation
32 à 48	DS2632
48mm et plus	nous contacter

# Poignées D-SIGN Montage Double

Façade de  
finition

Fixe Intérieure

Fixe Extérieure

D-SIGN  
+ Façade de  
finition

DS7719

DS7977

DS7791

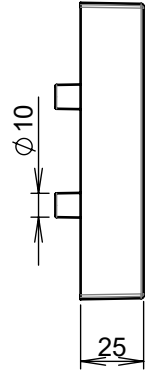
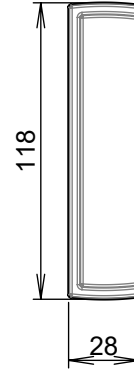
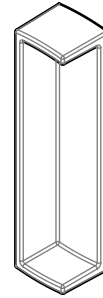
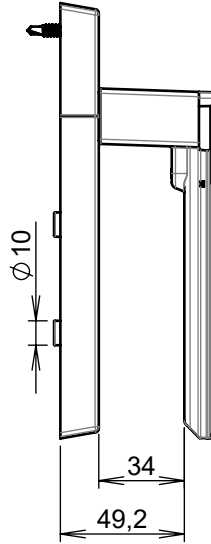
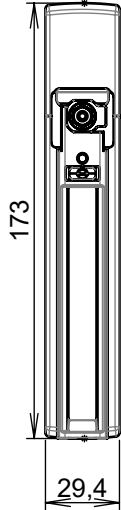
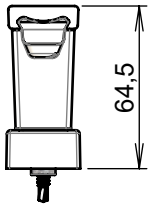
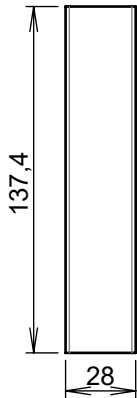
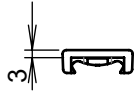
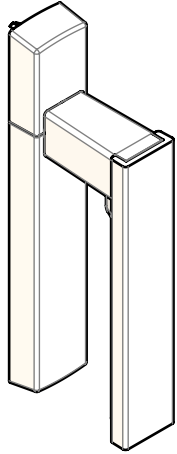

+ kit de fixation

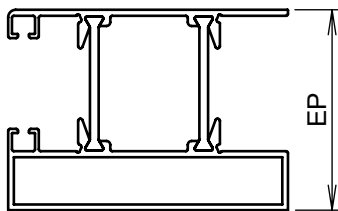
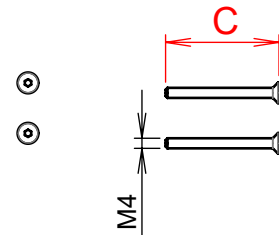

Epaisseur Profils	Réf kit de fixation	Longueur vis <b>C</b> (mm)
28.5 à 33.5	DS2841	40
33.5 à 38.5	DS2842	45

# Poignées D-SIGN Montage Double

Façade de  
finition

Manoeuvrante Intérieure

Fixe Extérieure

D-SIGN  
+ Façade de  
finition

DS7719

DS7971-D/G  
DS7972-D/G

DS7947

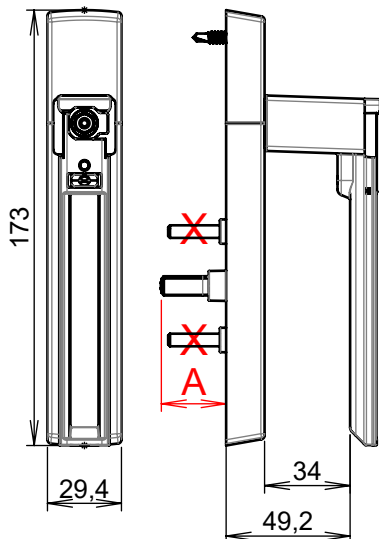
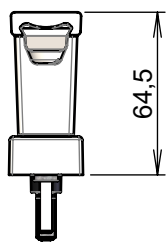
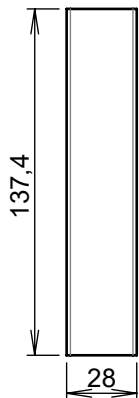
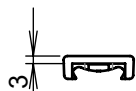
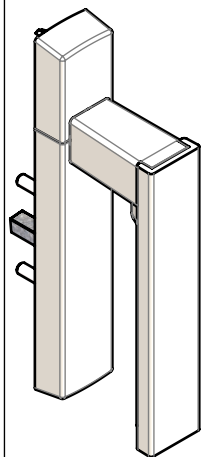

**X** remplacer vis  
par kit de fixation

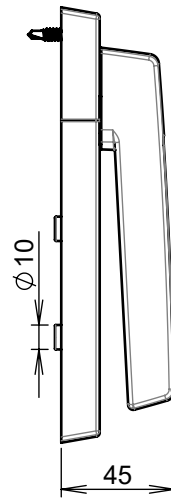
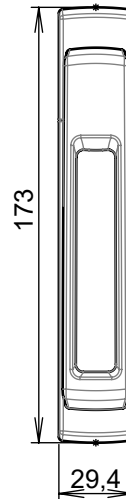
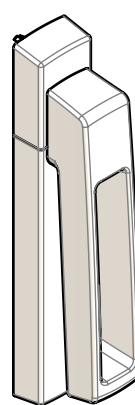

+ kit de fixation

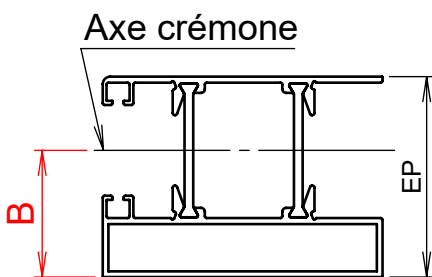
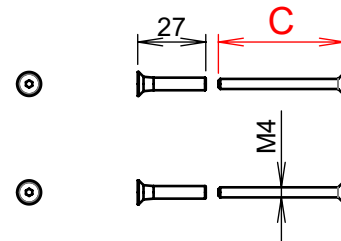

rallonge de carré  
DS6100A

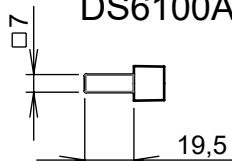

Epaisseur Profils	Réf poignées intérieure	valeur A	Réf kit de fixation	valeur C
32 à 35	DS7971-D/G	25.7	DS2632	50
35 à 48	DS7972-D/G	32.7	DS2632	50
47.5 à 57.5	DS7972-D/G	32.7	DS2625	60
	DS7972-D/G	32.7	DS2563	60
	DS7972-D/G	32.7	DS2626	60
	DS7972-D/G	32.7	DS2627	60
	DS7972-D/G	32.7	DS2628	60
57.5 à 69.5	DS7972-D/G	32.7	DS2662	70
	DS7972-D/G	32.7	DS2658	70
	DS7972-D/G	32.7	DS2661	70
	DS7972-D/G	32.7	DS2877	70
	DS7972-D/G	32.7	DS2682	70
	DS7972-D/G	32.7	DS2660	70

Ne pas utiliser le carré du kit

Si B>30mm:  
recoupe du carré à la longueur :B-11±1mm  
utilisation de la rallonge DS6100A

# Poignées D-SIGN Montage Double

Façade de  
finition

Manoeuvrante Intérieure

Fixe Extérieure

D-SIGN  
+ Façade de  
finition

DS7719

DS7971-D/G  
DS7972-D/G

DS7791

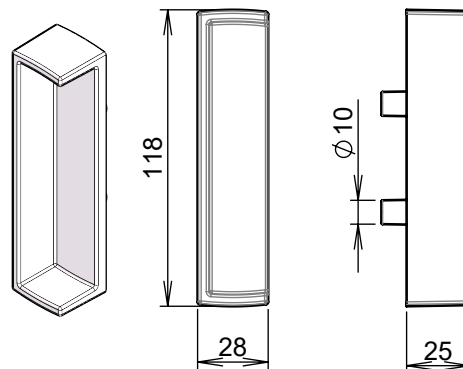
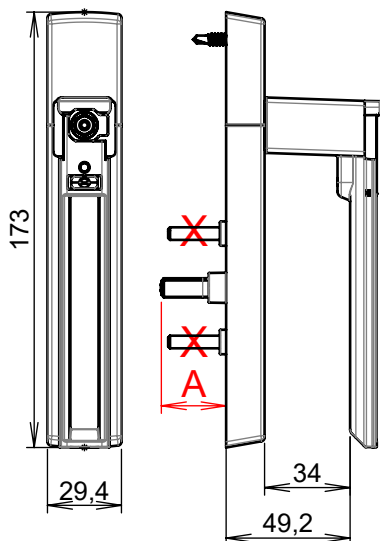
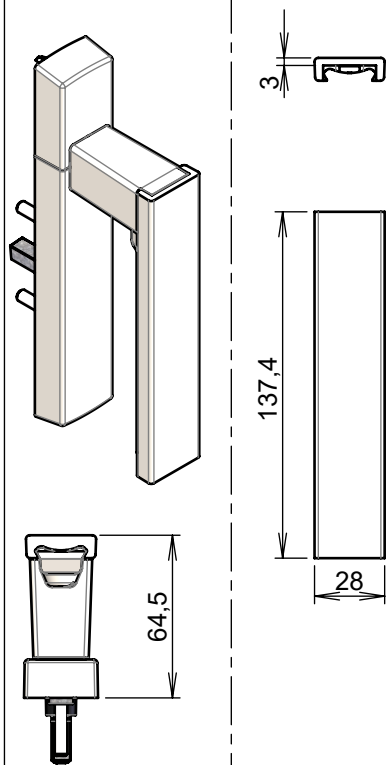

+ kit de fixation

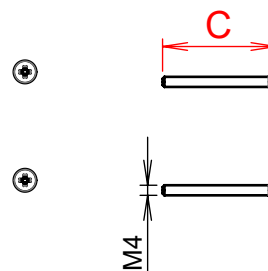

**X** remplacer vis  
par kit de fixation

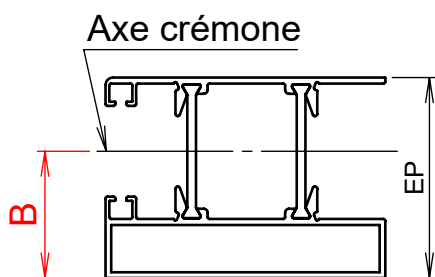

Epaisseur Profils	Réf poignées intérieure	valeur A	Réf kit de fixation	valeur C
28.5 à 33.5	DS7971-D/G	25.7	DS2841	40
33.5 à 35	DS7971-D/G	25.7	DS2470	45
35 à 38.5	DS7972-D/G	32.7	DS2470	45
38.5 à 43.5	DS7972-D/G	32.7	DS2471	50
43.5 à 48.5	DS7972-D/G	32.7	DS2472	55
48.5 à 53.5	DS7972-D/G	32.7	DS2473	60
53.5 à 58.5	DS7972-D/G	32.7	nous contacter	
58.5 à 63.5	DS7972-D/G	32.7	DS2759	70

Si  $B > 30\text{mm}$ :  
recoupe du carré à la longueur :  $B - 11 \pm 1\text{mm}$   
utilisation de la rallonge DS6100A

rallonge de carré  
DS6100A

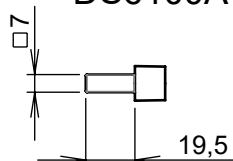

COUPE A-A

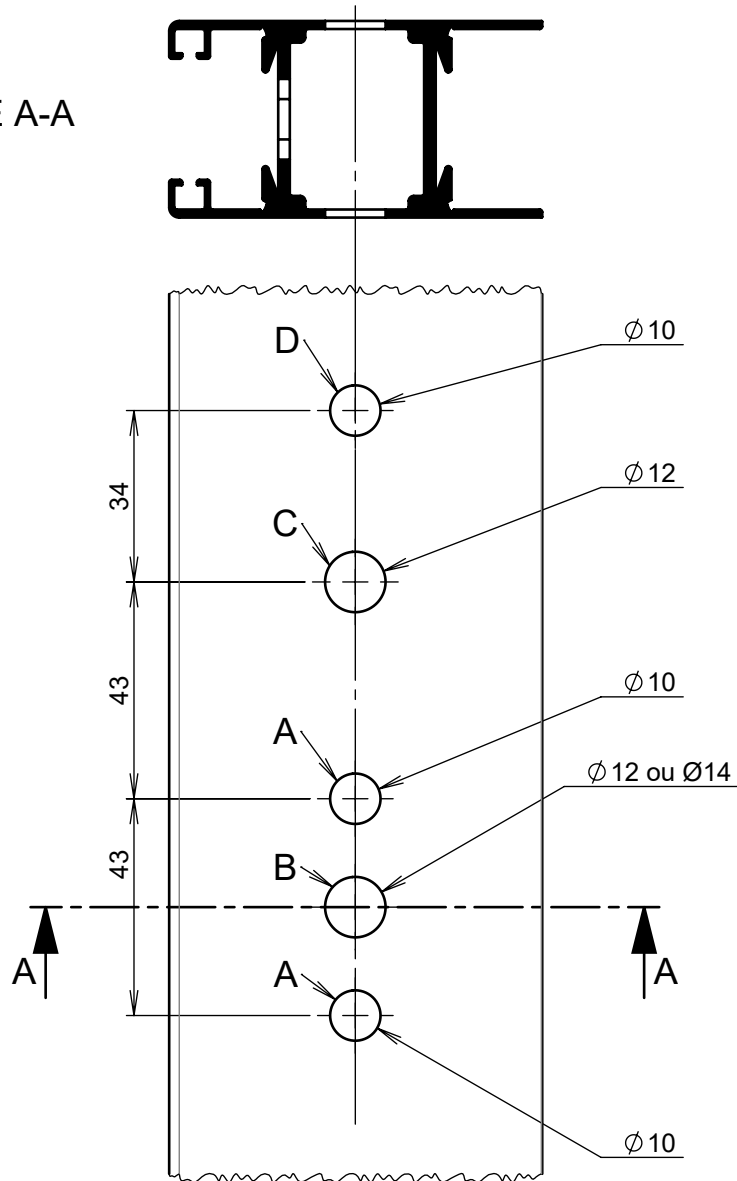

Tableau d'usines à réaliser

	<b>A</b> trou Ø10 Intérieur	<b>A</b> trou Ø10 Extérieur	<b>B</b> trou Intérieur	<b>C</b> trou Ø12 Int et Ext	<b>D</b> trou Ø10 Int et Ext
DS7971-D/G DS7972-D/G	● x2		Ø12 ● x1		
DS6100A			Ø14 ● x1		
DS7975	● x2				
DS7977	● x2				
DS7944-D/G		● x2		● x1	
DS7792-D/G		● x2		● x1	● x1
DS7947		● x2			
DS7791		● x2			